

Fabrication & Installation Guide

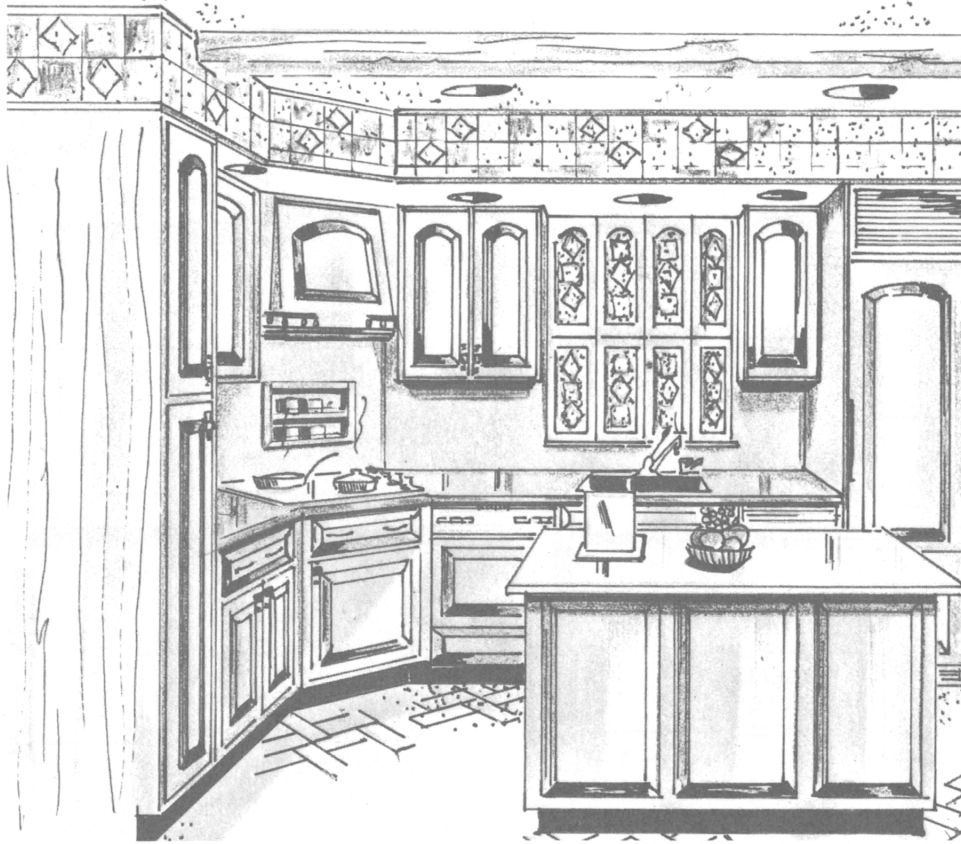

CONGRATULATIONS! You and your supplier have provided this home with the finest counter top ever made. Because we are very proud of our product, we ask that you follow these installation instructions for many years of trouble free and carefree living with your new postformed counter top.

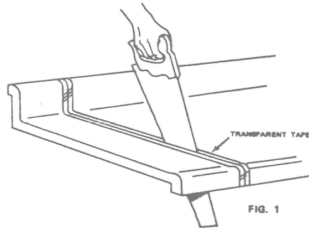

CUTTING

If counter top is to be cut to a specific size, measure length carefully and draw a heavy pencil line on the decorative surface from the top of the back-splash to the front edge of counter top. Cover the pencil line with a transparent tape before sawing which helps prevent chipping of the surface when cutting. Use a 10 to 12 point finishing saw for cutting. Cut should be made through the face of counter to prevent chipping of the surface (Fig. 1). Cut only on the down stroke.

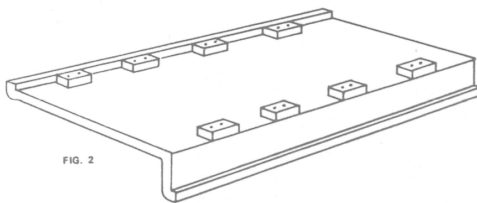

BUILD UP

Place counter top upside down on a flat surface (Fig. 2) and nail on blocks of wood spaced equal distance apart along front and back rails as shown. This simple build-up procedure is necessary for the counter to lie level on the cabinet.

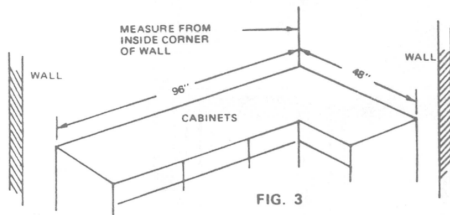

INSTRUCTIONS FOR CUTTING A 12' DOUBLE MITRE COUNTER TOP

Measuring for an "L" shape kitchen, be sure to measure from the inside corner of the wall for the length required. See Fig. 3. Now measure the top for the cut, and be sure to measure from the top of the backsplash on the mitre point. See Fig. 4.

NOTE: The 12' (144") double mitre may be cut to accommodate many different size kitchens:

Example:

- 36" x 108"
- 72" x 72"
- 60" x 48"
- 96" x 48"
- 84" x 60" and other intermediate sizes.

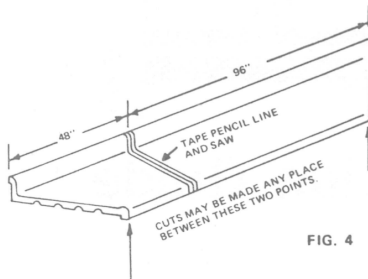

CUTTING INSTRUCTIONS

After getting your measurements carefully, draw a heavy pencil line on the decorative surface from the top of the backsplash to the front edge of the counter top. See Fig. 4. Cover the pencil line with a transparent tape before sawing which helps prevent chipping of the surface while cutting.

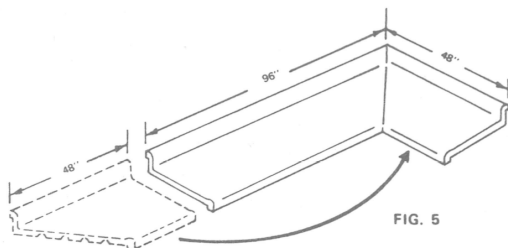

NOTE: Use a 10 to 12 point finishing saw for cutting and cut only on the down stroke. See Figure 1.

If using a circular saw to make a cut, turn the top over, measure carefully, and saw from the bottom side. The tape is still necessary on the decorative side to prevent chipping while sawing.

ASSEMBLING THE MITRE

The mitre is pre-cut and the necessary fasteners for joining left and right hand mitre sections are supplied with each left hand mitre unit. Mitre sections should be joined together before installation on cabinet. Follow these steps:

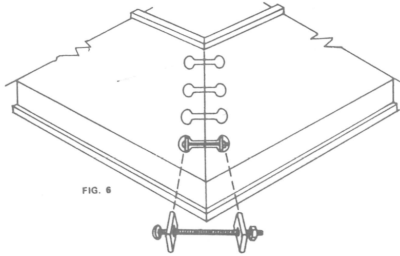

FIG. 6

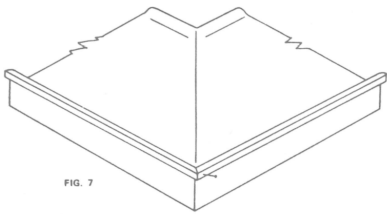

FIG. 7

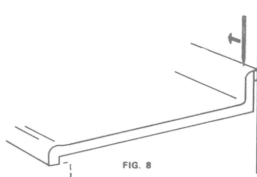

FIG. 8

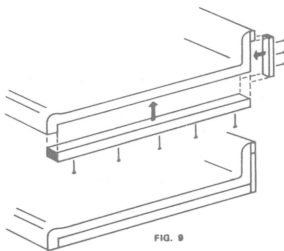

FIG. 9

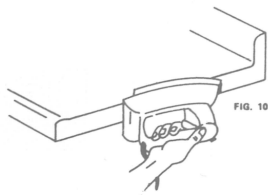

FIG. 10

1. If it is necessary to cut a mitre section down to a specific length, always cut from square end. (Follow cutting instructions above.)
2. Apply bead of glue to each mitre edge.
3. Place fasteners in position (Fig. 6) and tighten only enough to hold fasteners in place.
4. Match the no-drip front edges and tighten the nearest fastener.
5. Check seam where backsplash sections join. If flush, tighten the nearest fastener. Use a 1 1/4" nail (Fig. 7) and toenail the backsplash sections.
6. If entire seam is level, tighten the two remaining fasteners. If one section is higher than the other, place a wood block on raised area and strike lightly with a hammer or mallet to level the 2 sections. **DO NOT STRIKE AREA IMMEDIATELY OVER FASTENING BOLTS.** Then secure as they will fall out of place until they are tightened.

SCRIBE

Your postform counter top is provided with a scribe edge on the back splash which can be used to fit the wall. Follow these steps. (Fig. 8)

1. With the top on the cabinets, move it to the back, placing it as tight as possible against the wall.
2. With the body of a pencil as your guide, place the point of the pencil on the top of the back splash and rest the pencil against the wall.
3. By moving the pencil right or left, the unevenness in the wall will be transferred to the top of the back splash with the point of the pencil.
4. Remove the top, and with a belt sander or good block plane, follow the pencil line and scribe your top to the wall.

The end profile of your counter top should take this appearance with the build down strip and the scribe strip applied (Fig. 9)

APPLYING END CAPS

MATERIAL LIST

- 1 left hand end cap
- 1 right hand end cap
- 2 end batten strips 23-7/8" long
- 2 vertical batten strips 4" long
- 5/8" and 1 1/4" nails

CONTOURED END CAPS have adhesive back. Set household iron at 3/4 full heat. Simply iron on with **pressure**. Cool with damp sponge. See Figure 10.

CUTOUTS FOR SINK OR RANGE TOP

To cut an opening for a sink or range top, lay the top face down. Place the sink rim on the top where the sink is to be located and mark all the way around the edge of the rim, then make the cutout and install the sink. For rounded corners, a sabre saw must be used. If you are installing self-rimmed stainless steel sink, mark around the outer edge of the sink and cut out the hole 3/8" to 1/2" smaller than the line.

All appliance manufacturers furnish cutting instructions with their appliances.

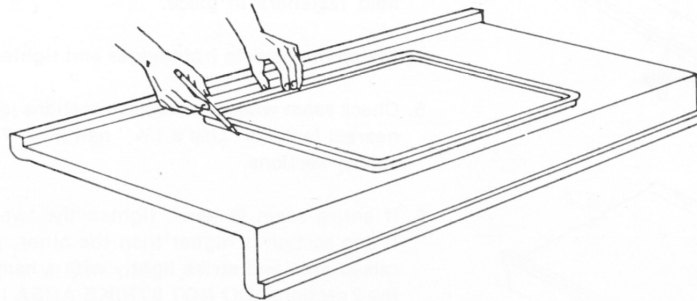

FASTENING

Dependent upon your cabinet, your top may be fastened in one of two prescribed ways.

1. If your cabinet has a top frame, you may secure your top with a 1 1/4" wood screw through this frame and into the top.
2. Without the top frame, it is suggested that you use 1" x 1" angle irons, and screws in proportion to the material thickness of cabinet and top. In most installations, only a few 1" x 1" angle irons are necessary to properly secure your counter top.

CARE

The decorative surface of your new counter top is highly resistant to staining, wear and heat. It is not, however, completely impervious.

HEAT: The material will withstand 275°F., which, in normal household use, is more than adequate to prevent damage. Do not place a hot pan or skillet directly on the counter top as these metals reach 500° to 600°.

FOODS AND CHEMICALS: Few chemicals and foods used in the kitchen will stain your counter top. If a slight stain should occur, it may be removed with mild cleanser containing a bleaching agent.

WAXING AND POLISHING are not necessary to keep your counter top looking its best. Soap, water and proper care will keep the working surface beautiful for many years.

Instructions for applying end caps are packed with end caps kit.

FACTORY INSPECTED

This product has been fully inspected at the time of manufacture and has passed strict quality controls regarding construction and surface characteristics.

